



# 硬质合金旋转锉毛坯

CEMENTED CARBIDE BURR BLANKS



厦门金鹭特种合金有限公司  
Xiamen Golden Egret Special Alloy Co.,Ltd.

## 公司简介 About GESAC

厦门金鹭特种合金有限公司，成立于1989年，是一家中外合资的国家高新技术企业，隶属于中国六大稀土集团之一的厦门钨业股份有限公司。公司致力于高品质钨粉末材料、硬质合金、精密切削工具等钨系列产品的研发、生产，以及行业专业解决方案的提供，是世界知名的钨粉末、硬质合金及切削工具供应商。

凭借完整钨产业链的产品集成技术研发，以及务实、创新的管理理念，厦门金鹭始终保持着强劲的发展势头，为全球用户提供最高性价比的钨粉末产品和服务，为现代工业领域解决高硬度、耐高温、耐磨损问题，提供了优良的产品和完善的解决方案，客户遍布全球四十多个工业发达国家和地区，享誉海内外。

公司拥有3个生产基地，3个海外销售公司和1个企业技术中心，独立承担并完成多项“国家科技支撑计划项目”，“国家科技重大专项”，“国家火炬计划项目”，“国家重点新产品”开发项目及省市重点研究课题，被评为“战略性新兴产业骨干企业”、“创新型企业”、“先进技术企业”。

Xiamen Golden Egret Special Alloy Co., Ltd. (GESAC), founded in 1989, is a Sino-foreign joint venture with national high-tech, affiliated with XTC, which is one of six major rare earth groups in China. GESAC is committed to research & development, production and professional solutions providing of high-quality tungsten powder materials, cemented carbide, precision cutting tools and other tungsten products. Up to now, GESAC has become world-famous manufacturer and supplier of tungsten powder, cemented carbide and precision cutting tools products.

With the Integrated Product Development of complete tungsten industry chain, as well as a pragmatic and innovative management concept, GESAC has always maintained a strong momentum of development, providing the cost effective tungsten powder products and services for global users, offering the excellent products and perfect solutions for solving high hardness, high temperature resistance and wear resistance topics. Our brand "Golden Egret" has become one of the leading brand in the market, enjoying famous reputation in more than 40 countries and regions.

GESAC owns three production bases, three overseas sales branches and one R&D center. We undertook and completed several development programs independently, including the "National Science and Technology Support Programs", the "National Torch Program Projects", and the "National Key Projects" and so on. GESAC was awarded as "Key Enterprise for Strategic Emerging Industry", "Innovative Enterprise" and "Enterprise with Advanced Technology".

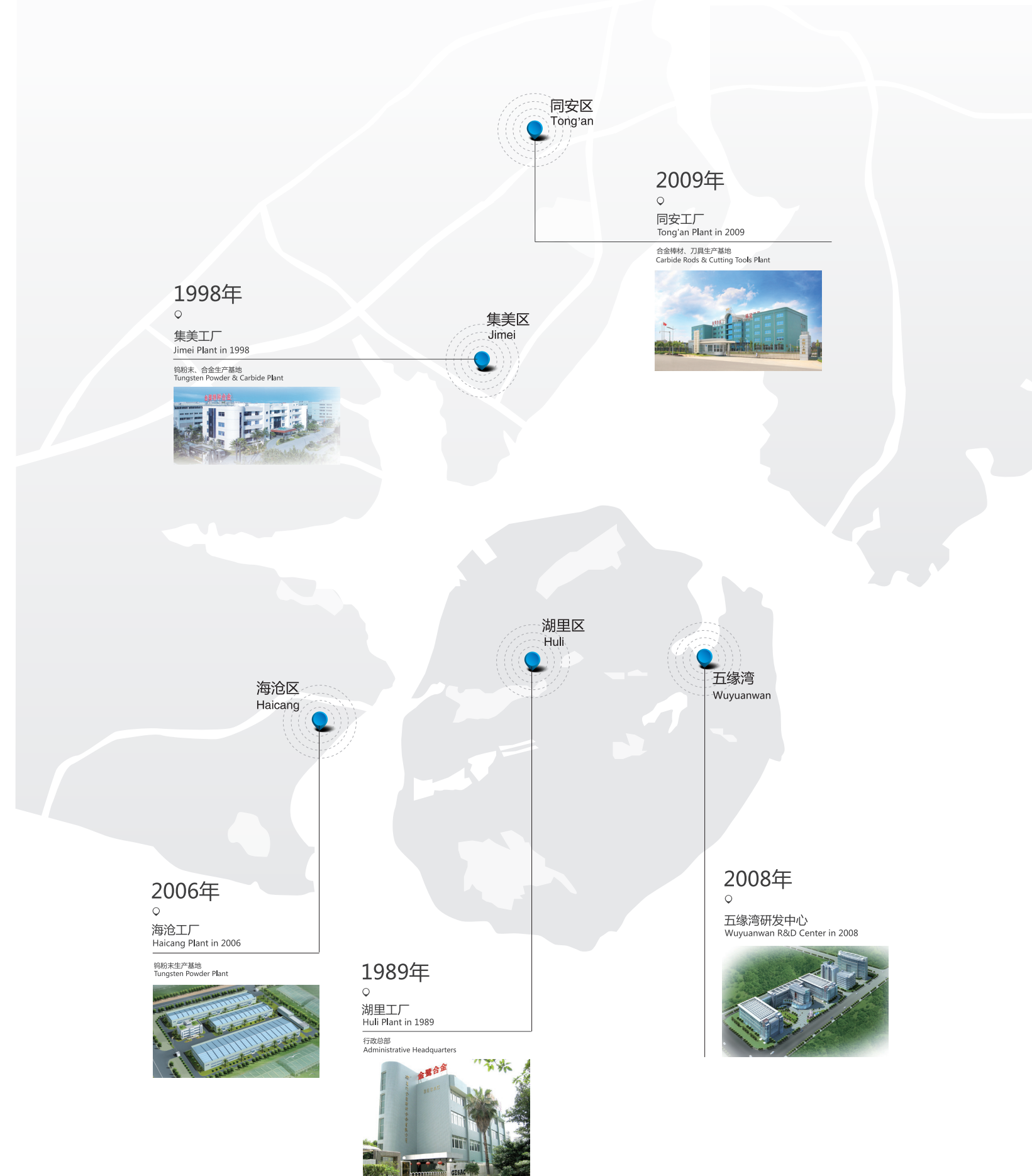

## 目录 Contents

<b>基本信息 Basic Information</b>	<b>A</b>
旋转锉牌号介绍 Grade Introduction of Cemented Carbide Burr Blanks	03
旋转锉产品（按外观分类） Burr Blanks with Available Shapes	04
旋转锉编码体系 Burr Blanks Encoding System	05
<b>产品介绍 Product Introduction</b>	<b>B</b>
圆柱形旋转锉毛坯 Shape ZA, Cylindrical	06
圆柱形球头旋转锉毛坯 Shape ZC, Cylindrical Round Nose	08
圆球形旋转锉毛坯 Shape ZD, Spherical	10
椭圆形旋转锉 Shape ZE, Oval	12
弧形圆头旋转锉毛坯 Shape ZF, Arch Round Nose	14
弧形尖头旋转锉毛坯 Shape ZF, Arch Pointed Nose	16
火炬形旋转锉毛坯 Shape ZH, Flame	18
60°圆锥形旋转锉毛坯 Shape ZJ, 60°Cone	20
90°圆锥形旋转锉毛坯 Shape ZK, 90°Cone	22
锥形圆头旋转锉毛坯 Shape ZL, Conical Round Nose	24
锥形尖头旋转锉毛坯 Shape ZM, Conical Pointed Nose	26
倒锥形旋转锉毛坯 Shape ZN, Inverted Cone	28
圆柱形带孔旋转锉毛坯 Shape ZA, Cylindrical with Brazing Hole	30
圆柱形球头带孔旋转锉毛坯 Shape ZC, Cylindrical Round Nose with Brazing Hole	31
弧形圆头带孔旋转锉毛坯 Shape ZF, Arch Round Nose with Brazing Hole	32
<b>附录 Appendix</b>	<b>C</b>
硬度换算表 Hardness Comparison	33

## 旋转锉牌号介绍









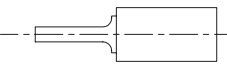
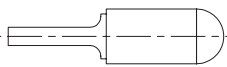

### Grade Introduction of Cemented Carbide Burr Blanks

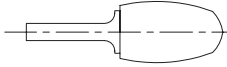
牌号 Grade	钴含量 Cobalt Content (%)	密度 Density (g/cm <sup>3</sup> )	硬度 Hardness (HRA)	WC晶粒度 WC Grain Size	抗弯强度 T.R.S (N/mm <sup>2</sup> )	牌号描述/应用 Grades Introduction / Applications	建议 焊接方式 Recommended Welding Method
GK15E	7.0	14.80	90.4	中颗粒 Medium	3000	耐磨性好，韧性高，主要运用于工业旋转锉刀。 Good wear resistance, higher toughness, mainly use for industrial burrs.	银/铜焊 Silver or Copper
GK10B	6.0	14.95	90.8	中颗粒 Medium	2700	耐磨性好，同时具有一定的韧性，主要应用于工业旋转锉刀。 Better wear resistance, high toughness, mainly use for industrial burrs.	银焊 Silver
GU20	10.3	14.42	91.8	细颗粒 Fine	3500	耐磨性很好，韧性很高，主要用于高性能工业旋转锉刀及牙科旋转锉刀。 Excellent wear resistance, excellent toughness, Mainly use for high performance industrial burrs and dental burrs.	银/铜焊 Silver or Copper
GU10UF	6.0	14.80	94.0	超细颗粒 Ultra-Fine	3800	耐磨性非常好，韧性很高，主要应用于美甲旋转锉及有色金属加工。 Extremely excellent wear resistance and toughness, mainly use for nail burrs, also for the manufacturing of nonferrous metal.	银焊 Silver

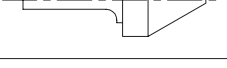

### 旋转锉产品 (按外观分类)

Burr Blanks with Available Shapes

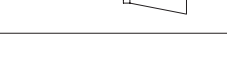
形状 SHAPE	分类 TYPE	型号 SHAPE (GESAC)	型号 SHAPE (ANSI)	型号 SHAPE (DIN 8033)	页码 PAGE
	圆柱形 Cylindrical	ZA	SA	ZYA	06
	圆柱形球头 Cylindrical Round Nose	ZC	SC	WRC	08
	圆球形 Spherical	ZD	SD	KUD	10
	椭圆形 Oval	ZE	SE	TRE	12
	弧形圆头 Arch Round Nose	ZF	SF	RBF	14
	弧形尖头 Arch Pointed Nose	ZG	SG	SPG	16
	火炬形 Flame	ZH	SH	--	18
	60°圆锥形 60°Cone	ZJ	SJ	KSJ	20
	90°圆锥形 90°Cone	ZK	SK	KSK	22
	锥形圆头 Conical Round Nose	ZL	SL	KEL	24
	锥形尖头 Conical Pointed Nose	ZM	SM	SKM	26
	倒锥形 Inverted Cone	ZN	SN	WKN	28

### 旋转锉编码体系

Burr Blanks Encoding System

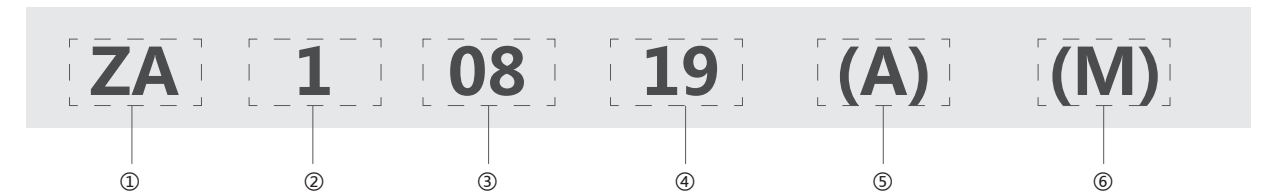

- ①：形状代码 GESAC Shape Code
- ②：型号小类代码 Model Small Class Code
- ③：产品外径 OD
- ④：产品高度 Height
- ⑤：产品流水号 Product Serial Number
- ⑥：M特指ISO公制 M Refers to ISO Standard Particularly

圆柱形旋转锉毛坯 – ANSI英制  
Shape ZA, Cylindrical – ANSI Standard

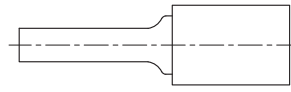

适用于生产圆柱形的旋转锉刀  
Suitable for making Cylindrical Carbide Burr Tools

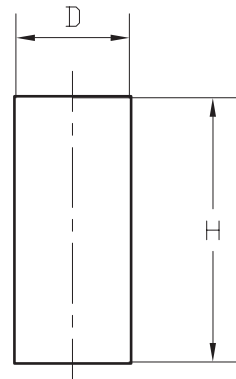

型号 Type	ANSI 英制 ANSI Standard	ΦD (mm)	H (mm)
ZA10604	BSA-51 S	6.73±0.13	4.90±0.13
ZA10612	BSA-51	6.73±0.13	12.70±0.25
ZA10819	BSA-2	8.31±0.13	19.05±0.25
ZA10919	BSA-3	9.91±0.13	19.05±0.25
ZA11125	BSA-4	11.51±0.13	25.40±0.25
ZA11325	BSA-5	13.08±0.13	25.40±0.25
ZA11625	BSA-6	16.26±0.13	25.40±0.25
ZA11919	BSA-72	19.48±0.15	19.05±0.25
ZA11925	BSA-7	19.48±0.15	25.40±0.25
ZA12225	BSA-8	22.66±0.15	25.40±0.25
ZA12525	BSA-9	25.88±0.18	25.40±0.25

注：可按需定制  
Note: Customized According to Requirement

圆柱形旋转锉毛坯 – ISO公制  
Shape ZA, Cylindrical – ISO Standard

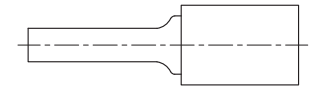

适用于生产圆柱形的旋转锉刀  
Suitable for making Cylindrical Carbide Burr Tools

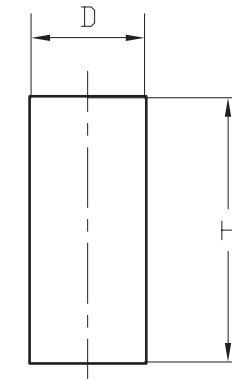

型号 Type	ISO 公制 ISO Standard	ΦD (mm)	H (mm)
ZA10616M	A0616	6.40±0.10	16.00±0.20
ZA10820M	A0820	8.40±0.10	20.00±0.20
ZA11020M	A1020	10.40±0.10	20.00±0.20
ZA11225M	A1225	12.40±0.10	25.00±0.20
ZA11425M	A1425	14.40±0.15	25.00±0.20
ZA11625M	A1625	16.40±0.15	25.00±0.20

注：可按需定制  
Note: Customized According to Requirement

圆柱形球头旋转锉毛坯 – ANSI英制  
Shape ZC, Cylindrical Round Nose – ANSI Standard

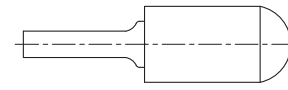

适用于生产圆柱形球头旋转锉刀  
Suitable for making Cylindrical Round Nose Carbide Burr Tools

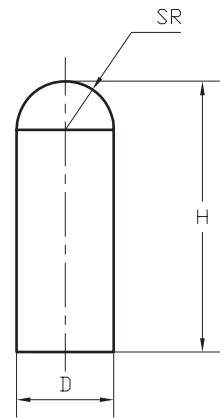

型号 Type	ANSI 英制 ANSI Standard	ΦD (mm)	H (mm)	SR (mm)
ZC10612	BSC-51	6.73±0.13	12.70±0.25	3.37
ZC10819	BSC-2	8.31±0.13	19.05±0.25	4.17
ZC10919	BSC-3	9.91±0.13	19.05±0.25	4.95
ZC11125	BSC-4	11.51±0.13	25.40±0.25	5.77
ZC11325	BSC-5	13.08±0.13	25.40±0.25	6.55
ZC11625	BSC-6	16.26±0.13	25.40±0.25	8.13
ZC11912	BSC-15	19.48±0.15	12.70±0.25	9.75
ZC11919	BSC-16	19.48±0.15	19.05±0.25	9.74
ZC11925	BSC-7	19.48±0.15	25.40±0.25	9.75
ZC12525	BSC-9	25.88±0.18	25.40±0.25	12.95

注：可按需定制  
Note: Customized According to Requirement

圆柱形球头旋转锉毛坯 – ISO公制  
Shape ZC, Cylindrical Round Nose – ANSI Standard

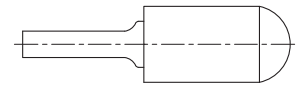

适用于生产圆柱形球头旋转锉刀  
Suitable for making Cylindrical Round Nose Carbide Burr Tools

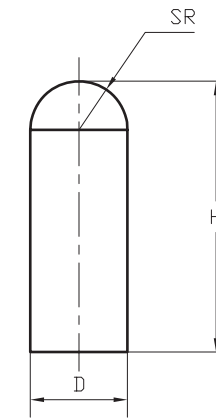

型号 Type	ISO 公制 ISO Standard	ΦD (mm)	H (mm)	SR (mm)
ZC10616M	C0616	6.40±0.10	16.00±0.20	3.20
ZC10820M	C0820	8.40±0.10	20.00±0.20	4.20
ZC11020M	C1020	10.40±0.10	20.00±0.20	5.20
ZC11225M	C1225	12.40±0.10	25.00±0.20	6.20
ZC11425M	C1425	14.40±0.15	25.00±0.20	7.20
ZC11625M	C1625	16.40±0.15	25.00±0.20	8.20

注：可按需定制  
Note: Customized According to Requirement

圆球形旋转锉毛坯 – ANSI英制  
Shape ZD, Spherical – ANSI Standard

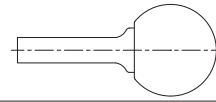

适用于生产圆球形旋转锉刀  
Suitable for making Spherical Carbide Burr Tools

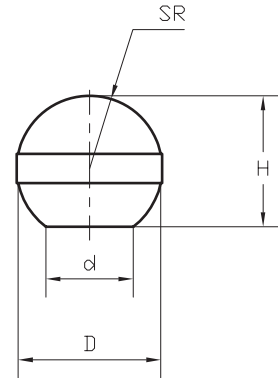

型号 Type	ANSI 英制 ANSI Standard	ΦD (mm)	H (mm)	SR (mm)
ZD10605A	BSD-1	6.73±0.13	5.74±0.13	3.37
ZD10807	BSD-2	8.31±0.13	7.15±0.13	4.16
ZD10908	BSD-3	9.91±0.13	8.59±0.13	4.96
ZD11110	BSD-4	11.51±0.13	10.08±0.13	5.76
ZD11311	BSD-5	13.08±0.13	11.58±0.15	6.54
ZD11614	BSD-6	16.26±0.13	14.58±0.15	8.13
ZD11917	BSD-7	19.48±0.15	17.58±0.15	9.74
ZD12523	BSD-9	25.88±0.18	23.60±0.15	12.94

注：可按需定制  
Note: Customized According to Requirement

圆球形旋转锉毛坯 – ISO公制  
Shape ZD, Spherical – ISO Standard

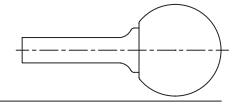

适用于生产圆球形旋转锉刀  
Suitable for making Spherical Carbide Burr Tools

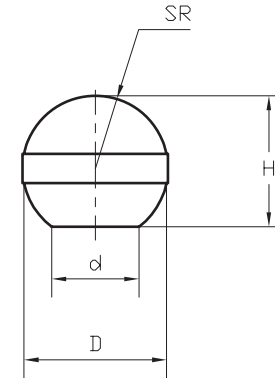

型号 Type	ISO 公制 ISO Standard	ΦD (mm)	H (mm)	SR (mm)
ZD10504M	D0504	5.40±0.10	4.50±0.10	2.70
ZD10605M	D0605	6.40±0.10	5.00±0.10	3.20
ZD10807M	D0807	8.40±0.10	7.20±0.10	4.20
ZD11009M	D1009	10.40±0.10	9.00±0.10	5.20
ZD11211M	D1211	12.40±0.10	11.20±0.20	6.20
ZD11412M	D1412	14.40±0.15	12.00±0.20	7.20
ZD11614M	D1614	16.40±0.15	14.00±0.20	8.20

注：可按需定制  
Note: Customized According to Requirement

椭圆形旋转锉 – ANSI英制  
Shape ZE, Oval – ANSI Standard

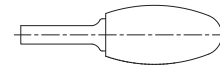

适用于生产椭圆形旋转锉刀  
Suitable for making Oval Carbide Burr Tools

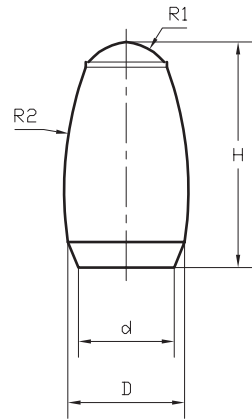

型号 Type	ANSI 英制 ANSI Standard	ΦD (mm)	H (mm)	R1 (mm)	R2 (mm)
ZE10508	BSE-53	5.21±0.13	8.13±0.13	2.18	10.85
ZE10609	BSE-51	6.73±0.13	9.53±0.13	2.51	10.85
ZE10915	BSE-3	9.91±0.13	15.88±0.25	4.09	22.35
ZE11322A	BSE-5	13.08±0.13	22.23±0.25	5.28	31.88
ZE11625	BSE-6	16.26±0.15	25.40±0.25	6.48	31.88
ZE11925	BSE-7	19.48±0.15	25.40±0.25	8.08	20.37

注：可按需定制  
Note: Customized According to Requirement

椭圆形旋转锉 – ISO公制  
Shape ZE, Oval – ISO Standard

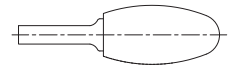

适用于生产椭圆形旋转锉刀  
Suitable for making Oval Carbide Burr Tools

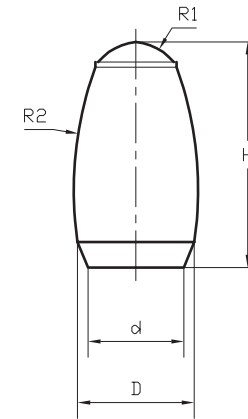

型号 Type	ISO 公制 ISO Standard	ΦD (mm)	H (mm)	R1 (mm)	R2 (mm)
ZE10610M	E0610	6.40±0.10	10.00±0.20	2.39	10.31
ZE10813M	E0813	8.40±0.10	13.00±0.20	3.70	20.00
ZE11016M	E1016	10.40±0.10	16.00±0.20	4.00	28.00
ZE11220M	E1220	12.40±0.10	20.00±0.20	5.00	30.00
ZE11422M	E1422	14.40±0.15	22.00±0.20	5.50	37.00
ZE11625M	E1625	16.40±0.15	25.00±0.20	6.54	32.17

注：可按需定制  
Note: Customized According to Requirement



### 弧形圆头旋转锉毛坯 – ANSI英制

Shape ZF, Arch Round Nose – ANSI Standard

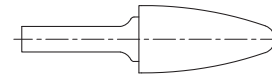

适用于生产弧形圆头旋转锉刀  
Suitable for making Arch Round Nose Carbide Burr Tools

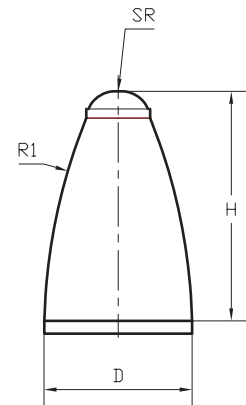

型号 Type	ANSI 英制 ANSI Standard	ΦD (mm)	H (mm)	SR (mm)	R1 (mm)
ZF20512	BSF-53	5.21±0.13	12.70±0.25	1.22	31.93
ZF20612	BSF-51	6.73±0.13	12.70±0.25	1.73	41.40
ZF20918	BSF-3	9.91±0.13	19.05±0.25	2.49	58.42
ZF21125	BSF-4	11.51±0.13	25.40±0.25	2.49	82.68
ZF21319	BSF-13	13.08±0.13	19.05±0.25	3.30	44.70
ZF21325	BSF-5	13.08±0.13	25.40±0.25	3.30	82.68
ZF21625	BSF-6	16.26±0.13	25.40±0.25	4.93	76.33
ZF21925	BSF-7	19.48±0.13	25.40±0.25	4.93	54.10
ZF21931	BSF-14	19.48±0.15	31.75±0.25	4.93	84.30
ZF21938	BSF-15	19.48±0.15	38.10±0.25	4.93	128.75

注：可按需定制  
Note: Customized According to Requirement

### 弧形圆头旋转锉毛坯 – ISO公制

Shape ZF, Arch Round Nose – ISO Standard

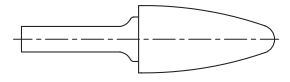

适用于生产弧形圆头旋转锉刀  
Suitable for making Arch Round Nose Carbide Burr Tools

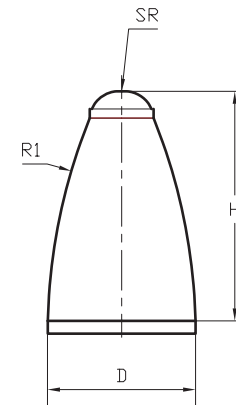

型号 Type	ISO 公制 ISO Standard	ΦD (mm)	H (mm)	SR (mm)	R1 (mm)
ZF20513M	F0513	5.40±0.10	13.00±0.20	1.26	33.08
ZF20618M	F0618	6.40±0.10	18.00±0.20	1.60	67.20
ZF20820M	F0820	8.40±0.10	20.00±0.20	2.10	63.34
ZF21020M	F1020	10.40±0.10	20.00±0.20	2.50	62.00
ZF21225M	F1225	12.40±0.10	25.00±0.20	2.61	68.26
ZF21425M	F1425	14.40±0.15	25.00±0.20	3.75	66.80
ZF21625M	F1625	16.40±0.15	25.00±0.20	4.97	76.99

注：可按需定制  
Note: Customized According to Requirement

### 弧形尖头旋转锉毛坯 – ANSI英制

Shape ZG, Arch Pointed Nose – ANSI Standard

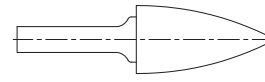

适用于生产弧形尖头旋转锉刀

Suitable for making Arch Pointed Nose Carbide Burr Tools

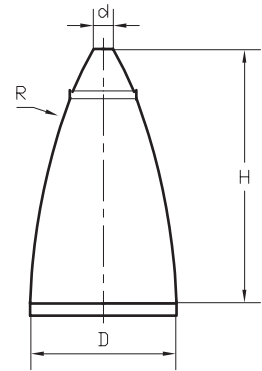

型号 Type	ANSI 英制 ANSI Standard	ΦD (mm)	H (mm)	Φd (mm)	R (mm)
ZG10612	BSG-51	6.73±0.13	12.70±0.25	1.07	25.53
ZG10819	BSG-2	8.31±0.13	19.05±0.25	1.40	50.93
ZG10919	BSG-3	9.91±0.13	19.05±0.25	1.42	38.23
ZG11319	BSG-13	13.08±0.13	19.05±0.25	1.85	33.48
ZG11325	BSG-5	13.08±0.13	25.40±0.25	1.85	57.28
ZG11625	BSG-6	16.26±0.13	25.40±0.25	1.85	47.75
ZG11925	BSG-7	19.48±0.15	25.40±0.25	1.91	41.43
ZG11938	BSG-15	19.48±0.15	38.10±0.25	2.24	86.31

注：可按需定制

Note: Customized According to Requirement

### 弧形尖头旋转锉毛坯 – ISO公制

Shape ZG, Arch Pointed Nose – ISO Standard

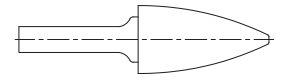

适用于生产弧形尖头旋转锉刀

Suitable for making Arch Pointed Nose Carbide Burr Tools

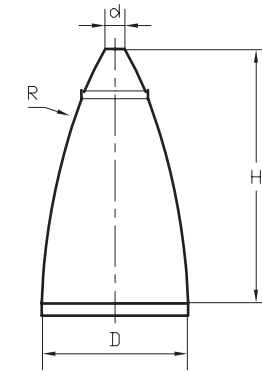

型号 Type	ISO 公制 ISO Standard	ΦD (mm)	H (mm)	Φd (mm)	R (mm)
ZG10618M	G0618	6.40±0.10	18.00±0.20	1.50	66.80
ZG10820M	G0820	8.40±0.10	20.00±0.20	1.40	50.93
ZG11020M	G1020	10.40±0.10	20.00±0.20	1.80	52.00
ZG11225M	G1225	12.40±0.10	25.00±0.20	1.40	53.22
ZG11425M	G1425	14.40±0.15	25.00±0.20	1.85	55.00
ZG11625M	G1625	16.40±0.15	25.60±0.20	1.87	48.16

注：可按需定制

Note: Customized According to Requirement

火炬形旋转锉毛坯 – ANSI英制  
Shape ZH, Flame – ANSI Standard

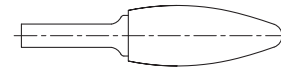

适用于生产火炬形旋转锉刀  
Suitable for making Flame Carbide Burr Tools

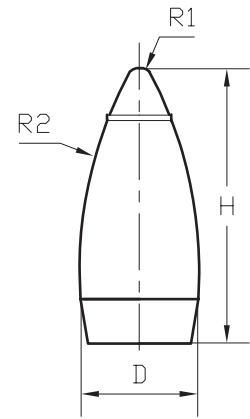

型号 Type	ANSI 英制 ANSI Standard	ΦD (mm)	H (mm)	R1 (mm)	R2 (mm)
ZH10819	BSH-2	8.31±0.13	19.05±0.25	1.73	27.13
ZH11331	BSH-5	13.08±0.13	31.75±0.38	2.51	50.93
ZH11636	BSH-6	16.26±0.13	36.53±0.38	2.51	19.18
ZH11941	BSH-7	19.48±0.15	41.28±0.51	4.11	47.78

注：可按需定制  
Note: Customized According to Requirement

火炬形旋转锉毛坯 – ISO公制  
Shape ZH, Flame – ISO Standard

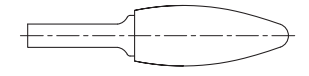

适用于生产火炬形旋转锉刀  
Suitable for making Flame Carbide Burr Tools

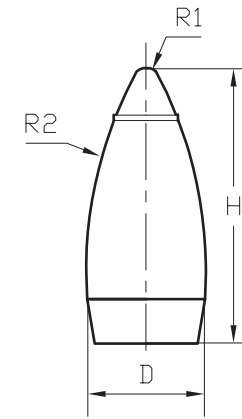

型号 Type	ISO 公制 ISO Standard	ΦD (mm)	H (mm)	R1 (mm)	R2 (mm)
ZH10613M	H0613	6.40±0.10	13.00±0.20	1.90	22.60
ZH10618M	H0618	6.40±0.10	18.00±0.20	1.50	40.10
ZH10820M	H0820	8.40±0.10	20.00±0.20	2.10	36.00
ZH11025M	H1025	10.40±0.10	25.00±0.20	2.60	35.70
ZH11232M	H1232	12.40±0.10	32.00±0.20	3.00	43.10
ZH11432M	H1432	14.40±0.15	32.00±0.20	3.50	45.50
ZH11636M	H1636	16.40±0.15	36.00±0.20	2.53	40.75

注：可按需定制  
Note: Customized According to Requirement

### 60°圆锥形旋转锉毛坯 – ANSI英制

Shape ZJ, 60°Cone – ANSI Standard

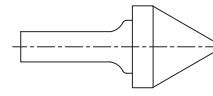

适用于生产60°圆锥形旋转锉刀

Suitable for making 60°Cone Carbide Burr Tools

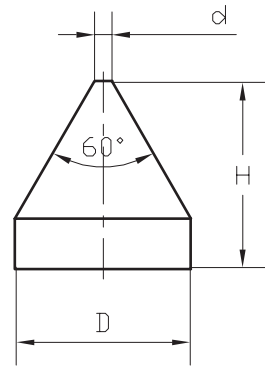

型号 Type	ANSI 英制 ANSI Standard	ΦD (mm)	H (mm)	Φd (mm)
ZJ10911	BSJ-3	9.91±0.13	11.13±0.25	0.81
ZJ11313	BSJ-5	13.08±0.13	13.89±0.25	0.81
ZJ11617	BSJ-6	16.26±0.13	17.48±0.25	1.60
ZJ11920	BSJ-7	19.48±0.15	20.24±0.25	1.60
ZJ12524	BSJ-9	25.88±0.18	24.61±0.25	3.18

注：可按需定制

Note: Customized According to Requirement

### 60°圆锥形旋转锉毛坯 – ISO公制

Shape ZJ, 60°Cone – ISO Standard

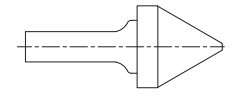

适用于生产60°圆锥形旋转锉刀

Suitable for making 60°Cone Carbide Burr Tools

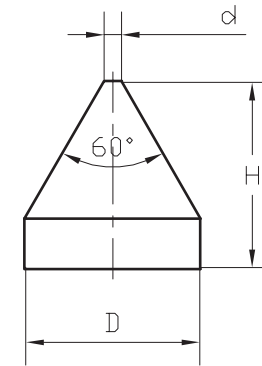

型号 Type	ISO 公制 ISO Standard	ΦD (mm)	H (mm)	Φd (mm)
ZJ11013M	J1008	10.40±0.10	13.50±0.20	0.81
ZJ11618M	J1613	16.40±0.15	18.80±0.20	1.60

注：可按需定制

Note: Customized According to Requirement

90°圆锥形旋转锉毛坯 – ANSI英制  
Shape ZK, 90°Cone – ANSI Standard

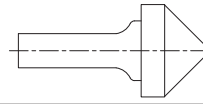

适用于生产90°圆锥形旋转锉刀  
Suitable for making 90°Cone Carbide Burr Tools

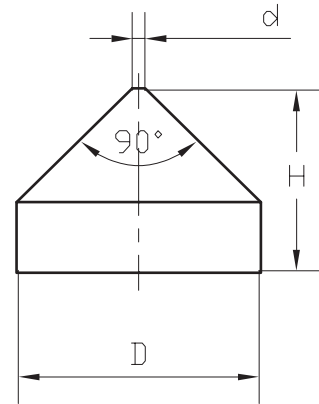

型号 Type	ANSI 英制 ANSI Standard	ΦD (mm)	H (mm)	Φd (mm)
ZK10907	BSK-3	9.91±0.13	7.95±0.25	0.81
ZK11309	BSK-5	13.08±0.13	9.53±0.25	0.81
ZK11612	BSK-6	16.26±0.13	12.29±0.25	1.60
ZK11913	BSK-7	19.48±0.15	13.89±0.25	1.60
ZK12516	BSK-9	25.88±0.18	16.28±0.25	3.18

注：可按需定制  
Note: Customized According to Requirement

90°圆锥形旋转锉毛坯 – ISO公制  
Shape ZK, 90°Cone – ISO Standard

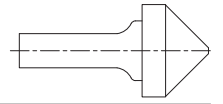

适用于生产90°圆锥形旋转锉刀  
Suitable for making 90°Cone Carbide Burr Tools

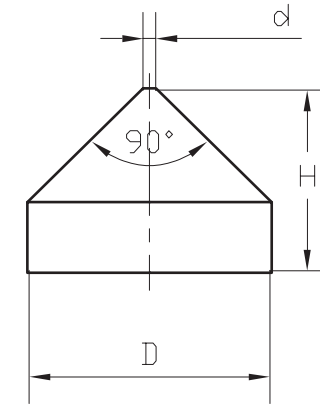

型号 Type	ISO 公制 ISO Standard	ΦD (mm)	H (mm)	Φd (mm)
ZK11010M	K1010	10.40±0.10	10.30±0.20	0.81
ZK11211M	K1211	12.40±0.10	11.30±0.20	0.81
ZK11613M	K1613	16.40±0.15	13.30±0.20	1.60

注：可按需定制  
Note: Customized According to Requirement



### 锥形圆头旋转锉毛坯 – ANSI英制

Shape ZL, Conical Round Nose – ANSI Standard

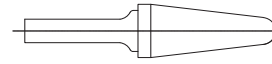

适用于生产锥形圆头旋转锉刀

Suitable for making Conical Round Nose Carbide Burr Tools

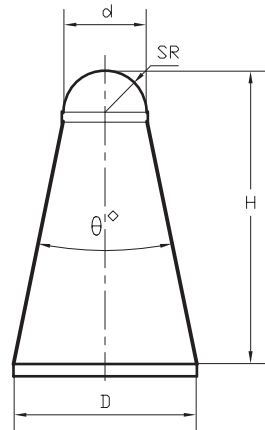

型号 Type	ANSI 英制 ANSI Standard	ΦD (mm)	H (mm)	SR (mm)	θ
ZL10825	BSL-2	8.31±0.13	25.78±0.25	1.52	14°
ZL10930	BSL-3	9.91±0.13	30.68±0.38	1.78	14°
ZL11332A	BSL-4	13.08±0.13	32.28±0.38	3.33	14°
ZL11633	BSL-5	16.26±0.13	33.86±0.38	4.90	14°
ZL11637	BSL-6	16.26±0.13	37.03±0.38	3.81	14°
ZL11941	BSL-7	19.48±0.15	41.81±0.51	5.64	14°

注：可按需定制

Note: Customized According to Requirement

### 锥形圆头旋转锉毛坯 – ISO公制

Shape ZL, Conical Round Nose – ISO Standard

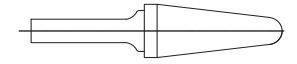

适用于生产锥形圆头旋转锉刀

Suitable for making Conical Round Nose Carbide Burr Tools

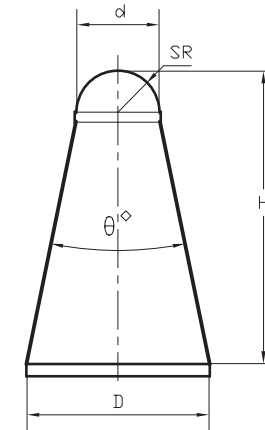

型号 Type	ISO 公制 ISO Standard	ΦD (mm)	H (mm)	SR (mm)	θ
ZL10512M	L0512	5.40±0.10	12.40±0.20	1.40	14°
ZL10616M	L0616	6.40±0.10	16.00±0.20	1.50	14°
ZL10822M	L0822	8.40±0.10	22.00±0.20	2.10	12°
ZL11025M	L1025	10.40±0.10	25.00±0.20	2.67	13°
ZL11228M	L1228	12.40±0.10	28.60±0.20	3.10	14°
ZL11428M	L1428	14.40±0.15	28.00±0.20	3.10	19°
ZL11633M	L1633	16.40±0.15	33.00±0.20	4.95	14°

注：可按需定制

Note: Customized According to Requirement

### 锥形尖头旋转锉毛坯 – ANSI英制

Shape ZM, Conical Pointed Nose – ANSI Standard

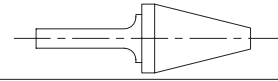

适用于生产锥形尖头旋转锉刀

Suitable for making Conical Pointed Nose Carbide Burr Tools

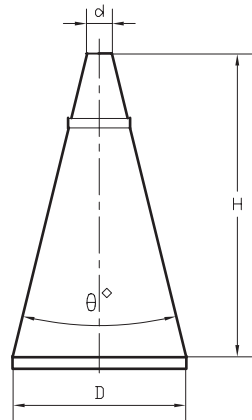

型号 Type	ANSI 英制 ANSI Standard	ΦD (mm)	H (mm)	Φd (mm)	θ
ZM10616	BSM-1	6.73±0.13	16.13±0.25	1.65	22°
ZM10919	BSM-4	9.91±0.13	19.30±0.25	1.85	28°
ZM11325	BSM-5	13.08±0.13	25.65±0.25	1.85	28°
ZM11628	BSM-6	16.26±0.13	28.98±0.38	2.03	31°

注：可按需定制

Note: Customized According to Requirement

### 锥形尖头旋转锉毛坯 – ISO公制

Shape ZM, Conical Pointed Nose – ISO Standard

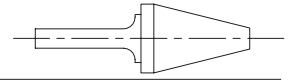

适用于生产锥形尖头旋转锉刀

Suitable for making Conical Pointed Nose Carbide Burr Tools

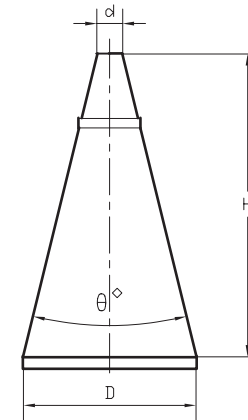

型号 Type	ISO 公制 ISO Standard	ΦD (mm)	H (mm)	Φd (mm)	θ
ZM10616M	M0616	6.40±0.10	16.00±0.20	2.00	14°
ZM10618M	M0618	6.40±0.10	18.00±0.20	2.00	14°
ZM10818M	M0818	8.40±0.10	18.00±0.20	2.00	21°
ZM11020M	M1020	10.40±0.10	20.00±0.20	2.00	25°
ZM11225M	M1225	12.40±0.10	25.00±0.20	2.00	24°
ZM11425M	M1425	14.40±0.15	25.00±0.20	3.00	27°
ZM11625M	M1625	16.40±0.15	25.00±0.20	3.00	31°

注：可按需定制

Note: Customized According to Requirement

### 倒锥形旋转锉毛坯 – ANSI英制

Shape ZN, Inverted Cone – ANSI Standard

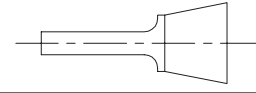

适用于生产倒锥形旋转锉刀  
Suitable for making Inverted Cone Carbide Burr Tools

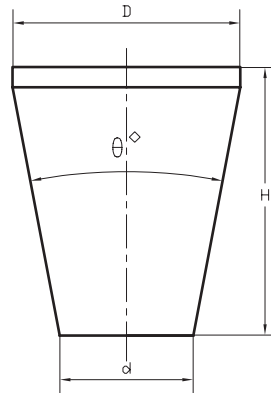

型号 Type	ANSI 英制 ANSI Standard	ΦD (mm)	H (mm)	Φd (mm)	θ
ZN10606	BSN-1	6.73±0.13	6.35±0.13	5.61	10°
ZN10909	BSN-2	9.90±0.13	9.53±0.13	7.80	10°
ZN11312A	BSN-3	13.08±0.13	12.70±0.25	9.65	16°
ZN11312	BSN-4	13.08±0.13	12.70±0.25	6.90	28°
ZN11619	BSN-6	16.26±0.13	19.05±0.25	10.38	18°
ZN11915	BSN-7	19.48±0.15	15.88±0.25	11.24	30°

注：可按需定制  
Note: Customized According to Requirement

### 倒锥形旋转锉毛坯 – ISO公制

Shape ZN, Inverted Cone – ISO Standard

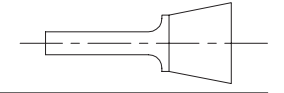

适用于生产倒锥形旋转锉刀  
Suitable for making Inverted Cone Carbide Burr Tools

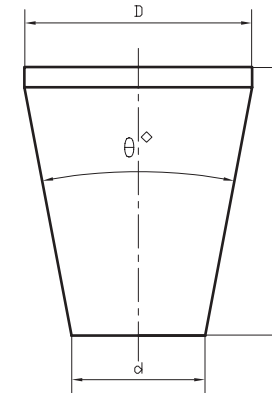

型号 Type	ISO 公制 ISO Standard	ΦD (mm)	H (mm)	Φd (mm)	θ
ZN10607M	N0607	6.40±0.10	7.00±0.10	5.23	10°
ZN11213M	N1213	12.40±0.10	13.00±0.20	7.92	20°
ZN11213AM	N1213	12.40±0.10	13.00±0.20	5.59	30°
ZN11613M	N1616	16.40±0.15	13.00±0.20	9.59	30°
ZN11616M	N1613	16.40±0.15	16.00±0.20	10.86	20°

注：可按需定制  
Note: Customized According to Requirement

### 圆柱形带孔旋转锉毛坯

Shape ZA, Cylindrical with Brazing Hole

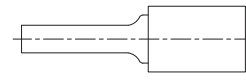

适用于生产圆柱形带焊接孔旋转锉刀

Suitable for making Cylindrical with Brazing Hole Carbide Burr Tools

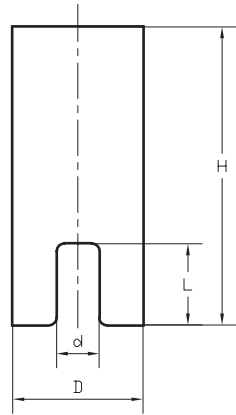

型号 Type	ΦD (mm)	H (mm)	Φd (mm)	L (mm)
ZA30512	5.70±0.10	12.90±0.10	2.6±0.20	3.1±0.20
ZA30820M	8.40±0.10	20.00±0.15	2.0±0.10	2.5±0.10
ZA31225M	12.40±0.10	25.00±0.25	4.5±0.20	6.5±0.20
ZA31325	13.08±0.13	25.40±0.25	4.5±0.20	6.5±0.20

注：可按需定制

Note: Customized According to Requirement

### 圆柱形球头带孔旋转锉毛坯

Shape ZC, Cylindrical Round Nose with Brazing Hole

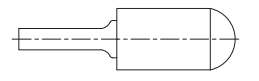

适用于生产圆柱形球头带焊接孔旋转锉刀

Suitable for making Cylindrical Round Nose with Brazing Hole Carbide Burr Tools

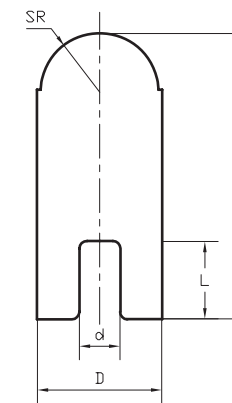

型号 Type	ΦD (mm)	H (mm)	SR (mm)	Φd (mm)	L (mm)
ZC30512	5.80±0.10	12.90±0.10	3.0	2.5±0.10	3.1±0.10
ZC30820M	8.40±0.10	20.00±0.20	4.20	2.0±0.10	2.5±0.10
ZC31225M	12.40±0.10	25.00±0.25	6.54	4.5±0.20	6.5±0.20
ZC31325	13.08±0.13	25.40±0.25	6.54	4.5±0.20	6.5±0.20

注：可按需定制

Note: Customized According to Requirement

### 弧形圆头带孔旋转锉毛坯

Shape ZF, Arch Round Nose with Brazing Hole

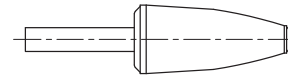

适用于生产弧形圆头带焊接孔旋转锉刀

Suitable for making Arch Round Nose with Brazing Hole Carbide Burr Tools

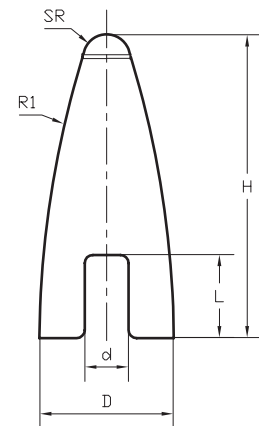

型号 Type	ΦD (mm)	H (mm)	SR (mm)	R1 (mm)	Φd (mm)	L (mm)
ZF31225M	12.40±0.10	25.00±0.25	2.61	68.26	4.5±0.20	6.5±0.20
ZF31325	13.08±0.13	25.40±0.25	3.3	82.68	4.5±0.20	6.5±0.20

注：可按需定制

Note: Customized According to Requirement

### 硬度换算表

Hardness Comparison

标准球 Standard Ball	布氏硬度10mm球 荷重3000kg			洛氏硬度(3R)			维氏硬度 HV 荷重 30kg
	Hult Green 球	碳化钨球 Carbide Ball	HRA 荷重60kg 金刚石	HRB 荷重100kg 1/6"球	HRC 荷重150kg 金刚石	HRD 荷重100kg 金刚石	
-	-	-	92.5	-	80.5	-	1700
-	-	-	92.0	-	80.0	-	1600
-	-	-	91.5	-	79.0	-	1550
-	-	-	91.0	-	78.0	-	1500
-	-	-	90.5	-	77.0	-	1450
-	-	-	90.0	-	76.0	-	1400
-	-	-	89.5	-	75.0	-	1350
-	-	-	89.0	-	74.0	-	1300
-	-	-	88.5	-	73.0	-	1250
-	-	-	88.0	-	72.0	-	1200
-	-	-	87.5	-	71.5	-	1150
-	-	-	87.0	-	71.0	-	1140
-	-	-	86.5	-	70.0	-	1076
-	-	-	86.0	-	69.0	-	1004
-	-	-	85.6	-	68.0	76.9	940
-	-	-	85.3	-	67.5	76.5	920
-	-	-	85.0	-	67.0	76.1	900
-	-	767	84.7	-	66.4	75.7	880
-	-	757	84.4	-	65.9	75.3	860
-	-	745	84.1	-	65.3	74.8	840
-	-	733	83.8	-	64.7	74.3	820
-	-	722	83.4	-	64.0	73.8	800
-	-	710	83.0	-	63.3	73.3	780
-	-	698	82.6	-	62.5	72.6	760
-	-	684	82.2	-	61.8	72.1	740
-	-	670	81.8	-	61.0	71.5	720
-	615	656	81.3	-	60.1	70.8	700
-	610	647	81.1	-	59.7	70.5	690
-	603	638	80.8	-	59.2	70.1	680
-	597	630	80.6	-	58.8	69.8	670
-	590	620	80.3	-	58.3	69.4	660
-	585	611	80.0	-	57.8	69.0	650
-	578	601	79.8	-	57.3	68.7	640
-	571	591	79.5	-	56.8	68.3	630



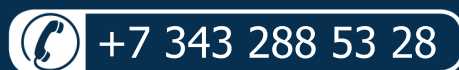

[www.gesac.ru](http://www.gesac.ru)

---

ООО "Точные Машины"

Официальный дистрибьютор GESAC в России и Казахстане  
620078, г. Екатеринбург, ул. Педагогическая, 8а, офис 23

Тел./факс: +7 343 288 53 28

e-mail: [zakaz@gesac.ru](mailto:zakaz@gesac.ru)

---